

## Apartment water meters

*Surface-mounted meter*

*Flush-mounted meter*

*Fitting meters*





### Certified quality

ZENNER International GmbH & Co. KG is DIN EN ISO 9001 and DIN EN ISO 14001 certified. All ZENNER meters correspond to the design and connection dimensions of DIN ISO 4064 and/or DIN ISO 19684 Part 3, DIN EN 1434, and other national and international standards and guidelines.

### MID compliant

Before we ship our water and heat meters, we calibrate them in our state-approved testing site for measurement instruments according to declare them compliant with MID European Measurement Instruments Directive 2014/32/EU.

We have successfully implemented approvals and procedures as per the guidelines of the MID since 2006.

### Contents

ETKD and ETWD.....	4
ETKD-L.....	6
ETKD R160 .....	8
ETKDI / ETWDI .....	10
AMR options .....	12
Universal meter M22 .....	14
Measuring capsule replacement program .....	15
Measuring capsule Minolist .....	16
ZENNER Flush mounting block 2" .....	17
Valve meter type MC .....	18
Bathtub meter type MC .....	18
Washbasin meter .....	19
Tap meter.....	19

# Technology of the highest standard

## Quality and reliability for the best measurement results

Customers around the world have relied on our experience and the quality and reliability of our products for more than 100 years. We sell more than three million water meters each year, which places us among the leading providers of innovative measurement technology on all five continents. We have the right products and custom solutions for all technological requirements available, in particular for our customers in the housing industry. Along with single-jet and capsule meters, this includes valve meters for additional installation on individual taps.



## Technology derived from experience

The technology in our products reflects our experience of over 100 years of development and production. We are constantly pushing the functionality of our meters forward in our on-going development process. This enables us to offer our customers products that will be functional for years to come.

All ZENNER single-jet and measuring capsule meters are dry dial. A magnetic coupling transfers the force between the wet area and the meter. This way the meter does not come into contact with water. This avoids disruptions or defects caused by impure water and guarantees precise measurement results and high measurement stability.





## ETKD and ETWD

### Single-jet dry-dial meter for cold and hot water

We developed a model with an electronic and non-reactive scannable modulator disc (ETKD-M/ ETWD-M) for smart-metering applications that require counters to have remote readability. The option of electronic scanning for the modulator disc is the basis for the remote reading of counter data, either via wireless radio, M-Bus or a pulser. By retrofitting our EDC module, the water meter is with a few hands a future-proof smart water. The ETKD-N or ETWD-N base models come standard-equipped with a magnet pointer and offer the option of transferring counter data via pulsers.



ETKD-M



ETKD-N

### Performance characteristics in overview

- Single-jet dry dial meter
- Model “-M” with 8-digit register and modulator disc (1 l/pulse) for non-reactive scanning for radio (wireless M-Bus, LPWAN), M-Bus or pulse
- Model “-N” with 7-digit register and magnetic pointer offers the possibility of remote readout of the meter data via pulser (10 l/pulse)
- Register cap made of high-quality UV-resistant polymer plastic
- Optional: Hermetically sealed glass/copper register IP68 equipped with register cap as a standard
- Register rotatable 355°
- For horizontal and vertical installation (also for ascending and descending pipes)
- Approved in accordance with MID

### Applications

- For the consumption measuring of cold potable water up to 30 °C (ETKD) or hot water up to 90 °C (ETWD)

### AMR options

- Model “-N” retrofittable with reed pulser (standard 10 l/pulse, optional 1 l/pulse)
- Model “-M” serially equipped with communication interface for:
  - Electronic Pulser
  - Wired M-Bus
  - Radio via Wireless M-Bus
  - Radio via LPWAN (LoRaWAN™, SIGFOX)



## Technical data ETKD, ETWD

Permanent Flowrate	Q <sub>3</sub>	m <sup>3</sup> /h	1.6	2.5	2.5	2.5	4
Comparable to nominal flow (EWG)	Q <sub>n</sub>	m <sup>3</sup> /h	1.0	1.5	1.5	1.5	2.5
Attainable measuring range	Q <sub>3</sub> /Q <sub>1</sub>	R	80H/40V	80H/40V	80H/40V	80H/40V	80H/40V
Standard measuring range (¹)	Q <sub>3</sub> /Q <sub>1</sub>	R	80H/40V	80H/40V	80H/40V	80H/40V	80H/40V
Comparable to metrological class (EWG)	class		B-H/A-V	B-H/A-V	B-H/A-V	B-H/A-V	B-H/A-V
Overload Flowrate	Q <sub>4</sub>	m <sup>3</sup> /h	2	3.125	3.125	3.125	5
Minimum Flowrate (²)	Q <sub>1</sub>	l/h	20H	31H/63V	31H/63V	31H/63V	50H/100V
Start-up flow rate	-	l/h	<10	<10	<10	<10	<14
Display range	min	l	0.02	0.02	0.02	0.02	0.02
	max	m <sup>3</sup>	R8 99.999,999 R7 99.999,99	R8 99.999,999 R7 99.999,99	R8 99.999,999 R7 99.999,99	R8 99.999,999 R7 99.999,99	R8 99.999,999 R7 99.999,99
Temperature range	T30 T90	°C	0,1 - 30 30 - 90	0,1 - 30 30 - 90	0,1 - 30 30 - 90	0,1 - 30 30 - 90	0,1 - 30 30 - 90
Operating pressure, max.	MAP	bar	16	16	16	16	16
Pulse value	-	l/pulse	1/10	1/10	1/10	1/10	1/10
Pressure loss at Q <sub>3</sub>	Δp	bar	Δ0.63	Δ0.63	Δ0.63	Δ0.63	Δ0.63
Mechanical environmental condition	-	-	M1	M1	M1	M1	M1
Climatic condition (³)	-	°C	5 - 70	5 - 70	5 - 70	5 - 70	5 - 70
Flow profile sensitivity	-	-	U0/D0	U0/D0	U0/D0	U0/D0	U0/D0
<b>Weight and dimensions:</b>							
Nominal diameter	DN	mm	15	15	15	20	20
		inch	½	½	½	¾	¾
Overall length	L2	mm	110	80	110/115	130	130
Overall length with connectors approx.	L1	mm	190	160	190/195	226	226
Thread meter G x B	D1	inch	¾	¾	¾	1	1
Thread connector	D2	inch	½	½	½	¾	¾
Width approx.	B	mm	66	66	66	66	66
Height approx.	H1	mm	77	77	77	80	80
Weight ca.	-	kg	0.43	0.42	0.43/0.44	0.57	0.57

- (¹) Other measuring ranges (R) on request  
 (²) The data refer to the standard measuring range  
 (³) Condensation possible

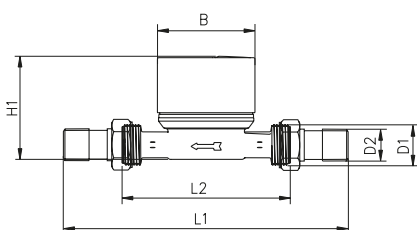

Dimensions ETKD / ETWD

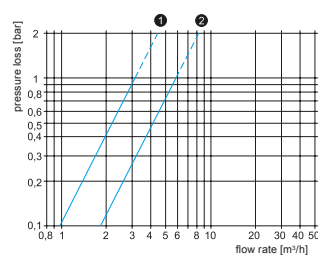

Typical pressure loss curve

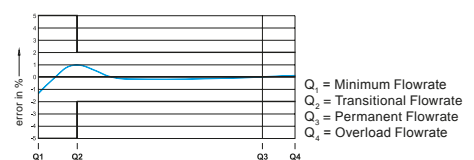

Typical accuracy curve



## ETKD-L

### Single-jet dry-dial meter for cold water in a lead-free polymer plastic housing

Our developers succeeded in combining the highly-precise measuring ETKD-insert with a body of pressure-tight plastic, suitable for use with potable water.

The result: extremely low weight with the highest stability and resilience. In addition, the ETKD-L is resistant to corrosion and free from heavy metals. In this way, the ETKD-L guarantees optimum drinking water quality and is safe in the future, especially with regard to the requirements of the Drinking Water Ordinance.

### Performance characteristics in overview

- Single-jet dry dial meter
- Model “-M” with 8-digit register and modulator disc (1 l/pulse) for non-reactive scanning for radio (wireless M-Bus, LPWAN), M-Bus or pulse
- Model “-N” with 7- or 8-digit register in addition offers the possibility of remote readout of the meter data via pulser (10 l/pulse)
- Body made of composite plastic approved for drinking water
- Register cap made of high-quality UV-resistant polymer plastic
- Optional: Hermetically sealed glass/copper register IP68 equipped with register cap as a standard
- Register rotatable 355°
- For horizontal and vertical installation (also for ascending and descending pipes)
- Approved in accordance with MID

### Applications

- For the consumption measuring of cold potable water up to 30 °C

### AMR options

- Model “-N” retrofittable with pulser (reed)
  - standard 10 l/pulse, optional 1 l/pulse
- Model “-M” serially equipped with communication interface for:
  - Electronic Pulser
  - Wired M-Bus
  - Radio via Wireless M-Bus
  - Radio via LPWAN (LoRaWAN™, SIGFOX)

## Technical data ETKD-L

Permanent Flowrate	$Q_3$	m <sup>3</sup> /h	2.5	4
Comparable to nominal flow (EWG)	$Q_n$	m <sup>3</sup> /h	1.5	2.5
Attainable measuring range	$Q_3/Q_1$	R	80H/40V	80H/40V
Standard measuring range (1)	$Q_3/Q_1$	R	80H/40V	80H/40V
Comparable to metrological class (EWG)	class		B-H/A-V	B-H/A-V
Overload Flowrate	$Q_4$	m <sup>3</sup> /h	3.125	5
Minimum Flowrate (2)	$Q_1$	l/h	31H/63V	50H/100V
Start-up flow rate	-	l/h	<10	<14
Display range	min	l	0.02	0.02
	max	m <sup>3</sup>	R8 99.999,999 R7 99.999,99	R8 99.999,999 R7 99.999,99
Temperature range	T30	°C	0.1 - 30	0.1 - 30
Operating pressure, max.	MAP	bar	10	10
Pulse value	-	l/pulse	1/10	1/10
Pressure loss at $Q_3$	$\Delta p$	bar	$\Delta 0.63$	$\Delta 0.63$
Mechanical environmental condition	-	-	M1	M1
Climatic condition (3)	-	°C	5 - 70	5 - 70
Flow profile sensitivity	-	-	U0/D0	U0/D0
<b>Weight and dimensions:</b>				
Nominal diameter	DN	mm	15	20
		inch	½	¾
Overall length	L2	mm	110/115	130
Overall length with connectors approx.	L1	mm	190/195	226
Thread meter G x B	D1	inch	¾	1
Thread connector	D2	inch	½	¾
Width approx.	B	mm	75	75
Height approx.	H1	mm	79	82
Weight ca.	-	kg	0.27	0.29

- (1) Other measuring ranges (R) on request  
 (2) The data refer to the standard measuring range  
 (3) Condensation possible

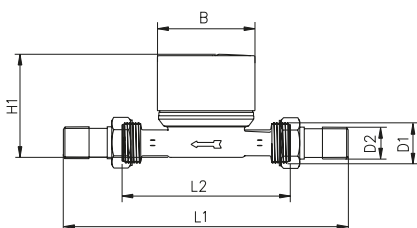

Dimensions ETKD-L

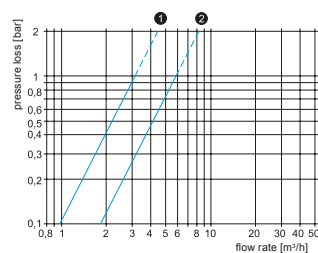

Typical pressure loss curve

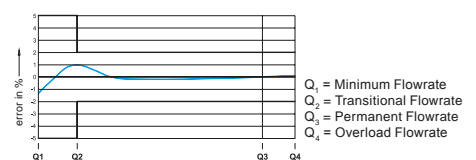

Typical accuracy curve



## ETKD R160

### High-precision single-jet meter with dry-dial register

The ETKD R160 represents the best starting values and the highest accuracy and measuring stability with an optimal price / performance ratio. Precisely in demanding measuring tasks, it delivers precise measuring results thanks to its design, which is thought through to the smallest detail:

- Hydraulically optimized body
- Improved bearing of the impeller
- Low-friction magnetic coupling

With a ratio of  $Q_3/Q_1=160$  (comparable to metrological class C) for horizontal installation, the ETKD R160 meets the highest standards of reliability and accuracy. In addition, the meter is robust and has a large measuring range. In the version „copper can“ (IP68), the register is enclosed in a robust copper jacket and, as a result, is optimally protected against condensation, dust and environmental influences.

Due to a wide range of technical options, the ETKD R160 is best possibly equipped for the future. The register with modulator disc is the base for data transfer via radio, M-Bus, wireless M-Bus or pulse.

### Performance characteristics in overview

- Dry dial register with shielded magnetic coupling
- Highest precision of the register
- Register equipped with 7- or 8-digits register
- Register rotatable 355°
- For horizontal and vertical installation
- Approved in accordance with MID

### Applications

- For the consumption measuring of cold potable water up to 50 °C

### AMR options

- ETKD R160 serially equipped with communication interface for:
  - Electronic Pulser
  - Wired M-Bus
  - Radio via Wireless M-Bus
  - Radio via LPWAN (LoRaWAN™, SIGFOX)



**Technical data ETKD R160**

Permanent Flowrate	Q <sub>3</sub>	m <sup>3</sup> /h	1.6	1.6	2.5	2.5	4	4
Comparable to nominal flow (EWG)	Q <sub>n</sub>	m <sup>3</sup> /h	1	1	1.5	1.5	2.5	2.5
Attainable measuring range	Q <sub>3</sub> /Q <sub>1</sub>	R	125H40V	125H40V	200H63V	200H63V	200H63V	200H63V
Standard measuring range (1)	Q <sub>3</sub> /Q <sub>1</sub>	R	100H40V	100H40V	160H63V	160H63V	160H63V	160H63V
Comparable to metrological class (EWG)	class		B-H/A-V	B-H/A-V	C-H/A-V	C-H/A-V	C-H/A-V	C-H/A-V
Overload Flowrate	Q <sub>4</sub>	m <sup>3</sup> /h	2	2	3.125	3.125	5	5
Minimum Flowrate (2)	Q <sub>1</sub>	l/h	16H/40V	16H/40V	16H/40V	16H/40V	25H/63V	25H/63V
Start-up flow rate	-	l/h	5	5	5	5	7	7
Display range	min.	l	0.02	0.02	0.02	0.02	0.02	0.02
	max.	m <sup>3</sup>	R8 99.999,999 R7 99.999,99	R8 99.999,999 R7 99.999,99	R8 99.999,999 R7 99.999,99	R8 99.999,999 R7 99.999,99	R8 99.999,999 R7 99.999,99	R8 99.999,999 R7 99.999,99
Temperature range	T50	°C	0.1 - 50	0.1 - 50	0.1 - 50	0.1 - 50	0.1 - 50	0.1 - 50
Operating pressure, max.	MAP	bar	16	16	16	16	16	16
Pulse value	-	l/pulse	1	1	1	1	1	1
Pressure loss at Q <sub>3</sub>	Δp	bar	Δ0.25	Δ0.25	Δ0.63	Δ0.63	Δ0.63	Δ0.63
Mechanical environmental condition	-	-	M1	M1	M1	M1	M1	M1
Climatic condition (3)	-	°C	5 - 55	5 - 55	5 - 55	5 - 55	5 - 55	5 - 55
Flow profile sensitivity	-	-	U0/D0	U0/D0	U0/D0	U0/D0	U0/D0	U0/D0
<b>Weight and dimensions:</b>								
Nominal diameter	DN	mm	15	15	15	15	20	20
		inch	½	½	½	½	¾	¾
Overall length	L2	mm	110	165/170	110	165/170	115/130	190
Overall length with connectors approx.	L1	mm	190	245/250	190	245/250	211/226	286
Thread meter G x B	D1	inch	¾	¾	¾	¾	1	1
Thread connector	D2	inch	½	½	½	½	¾	¾
Width approx.	B	mm	88	88	88	88	88	88
Height approx.	H1	mm	88	88	88	88	88	88
	H2	mm	15	15	15	15	16.5	16.5
Weight ca.	-	kg	0.55/0.61 <sup>(3)</sup>	0.70/0.76 <sup>(3)</sup>	0.55/0.61 <sup>(3)</sup>	0.70/0.76 <sup>(3)</sup>	0.68/0.71 <sup>(3)</sup>	1.29 <sup>(3)</sup>

(1) Other measuring ranges (R) on request

(2) The data refer to the standard measuring range

(3) IP68 (CC) versionn

(4) Condensation possible

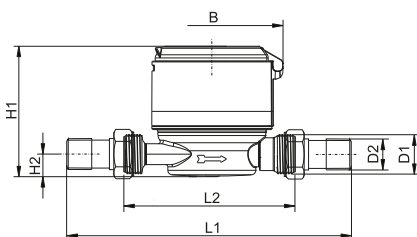

Dimensions ETKD R160

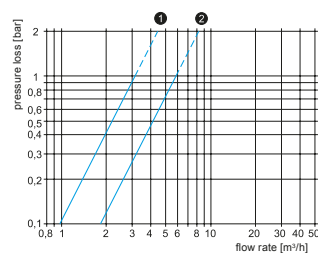

Typical pressure loss curve

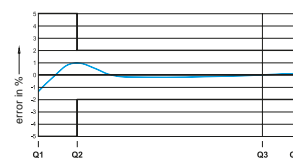

Typical accuracy curve



## ETKDI / ETWDI

### Single-jet dry dial meter with permanently mounted reed pulser

The ETKDI / ETWDI is a single-jet water meter developed by ZENNER with the new D-register and equipped with a pulser permanently installed ex works. The individual advantage of the ETKDI is an exceptional compact design. With its very small height, the meter easily adapts to any installation situation.

The ETKDI / ETWDI has a register with protected magnetic coupling and ensures an accurate collection of the meter data for the individual consumption billing in flats and apartments. The ETKDI / ETWDI is available with a 7-digit register and a pulse value of 10 l/pulse or with a 8-digit register and a pulse value of 1 l/pulse respective in the sizes  $Q_3=2,5$  und  $Q_3=4$ . Due to the already preinstalled pulser the ETKDI / ETWDI enables remote reading of the meter data. Using a special add-on module it can be integrated into an M-Bus or radio system.

### Performance characteristics in overview

- Dry dial register with shielded magnetic coupling
- Equipped during manufacturing with a reed pulser
- Low installation height
- Register rotatable 355°
- Operating pressure MAP 16
- For horizontal and vertical installation
- Approved in accordance with MID

### Applications

- For the consumption measuring of cold potable water up to 50 °C (ETKDI) or hot water up to 90 °C (ETWDI)

### AMR options

- ETKDI with permanently mounted reed pulser
  - Model with 7-digits register and 10 l/pulse
  - Model with 8-digits register and 1 l/pulse
- Radio via PDC-radio module
  - Wireless M-Bus
  - LPWAN (LoRaWAN™, SIGFOX)

## Technical data ETKDI/ETWDI

Permanent Flowrate	Q <sub>3</sub>	m <sup>3</sup> /h	1.6	2.5	2.5	2.5	4
Comparable to nominal flow (EWG)	Q <sub>n</sub>	m <sup>3</sup> /h	1.0	1.5	1.5	1.5	2.5
Attainable measuring range	Q <sub>3</sub> /Q <sub>1</sub>	R	80H/40V	80H/40V	80H/40V	80H/40V	80H/40V
Standard measuring range (1)	Q <sub>3</sub> /Q <sub>1</sub>	R	80H/40V	80H/40V	80H/40V	80H/40V	80H/40V
Comparable to metrological class (EWG)	class		B-H/A-V	B-H/A-V	B-H/A-V	B-H/A-V	B-H/A-V
Overload Flowrate	Q <sub>4</sub>	m <sup>3</sup> /h	2	3.125	3.125	3.125	5
Minimum Flowrate (2)	Q <sub>1</sub>	l/h	20H/40V	31H/63V	31H/63V	31H/63V	50H/100V
Start-up flow rate	-	l/h	<10	<10	<10	<10	<14
Display range	min.	l	0.02	0.02	0.02	0.02	0.02
	max.	m <sup>3</sup>	R8 99.999,999 R7 99.999,99	R8 99.999,999 R7 99.999,99	R8 99.999,999 R7 99.999,99	R8 99.999,999 R7 99.999,99	R8 99.999,999 R7 99.999,99
Temperature range	T50	°C	0,1 - 50	0,1 - 50	0,1 - 50	0,1 - 50	0,1 - 50
	T90	°C	30 - 90	30 - 90	30 - 90	30 - 90	30 - 90
Operating pressure, max.	MAP	bar	16	16	16	16	16
Pulse value	-	l/pulse	1/10	1/10	1/10	1/10	1/10
Pressure loss at Q <sub>3</sub>	Δp	bar	Δ0.63	Δ0.63	Δ0.63	Δ0.63	Δ0.63
Mechanical environmental condition	-	-	M1	M1	M1	M1	M1
Climatic condition (3)	-	°C	5 - 70	5 - 70	5 - 70	5 - 70	5 - 70
Flow profile sensitivity	-	-	U0/D0	U0/D0	U0/D0	U0/D0	U0/D0
<b>Weight and dimensions:</b>							
Nominal diameter	DN	mm	15	15	15	20	20
		inch	½	½	½	¾	¾
Overall length	L2	mm	110	80	110	130	130
Overall length with connectors approx.	L1	mm	190	160	190	226	226
Thread meter G x B	D1	inch	¾	¾	¾	1	1
Thread connector G x B	D2	inch	½	½	½	¾	¾
Width approx.	B	mm	66	66	66	66	66
Height approx.	H1	mm	76	76	76	79	79
Weight ca.	-	kg	0.43	0.42	0.43	0.59	0.59

(1) Other measuring ranges (R) on request

(2) The data refer to the standard measuring range

(3) Condensation possible

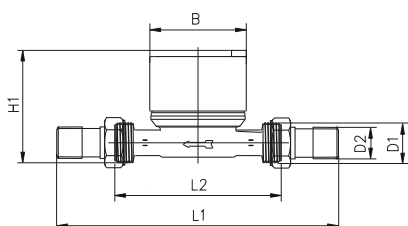

Dimensions ETKDI / ETWDI

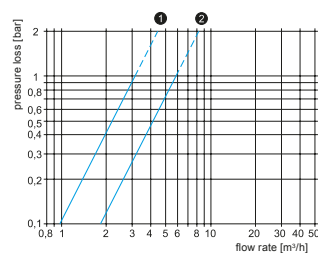

Typical pressure loss curve

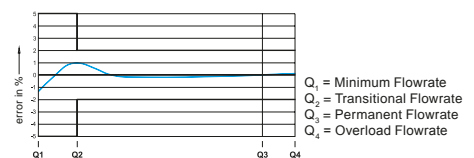

Typical accuracy curve

Q<sub>1</sub> = Minimum Flowrate  
Q<sub>2</sub> = Transitional Flowrate  
Q<sub>3</sub> = Permanent Flowrate  
Q<sub>4</sub> = Overload Flowrate

# AMR options

All single-jet meters equipped with a modulator disc have an 8-digit register. Due to a wide range of technical options, the ETKD is best possibly equipped for the future. The register with modulator disc is the base for data transfer via radio, pulse, M-Bus, wireless M-Bus or LPWA-networks on the Internet of Things.

All meters with modulator discs are prepared for mounting EDC communication modules as standard. The EDC modules are designed for outdoor use and can be retrofitted at any time.

## Communication interface EDC module for electronic pulser, M-Bus or radio

Meters with EDC module provide the following Smart Metering functions:

- Self-monitoring
- Tampering detection
- Dismounting of module and meter detection
- Reverse water flow detection
- Leakage detection
- Meter Stop detection
- Meter oversized detection
- Meter undersized respectively pipe burst detection

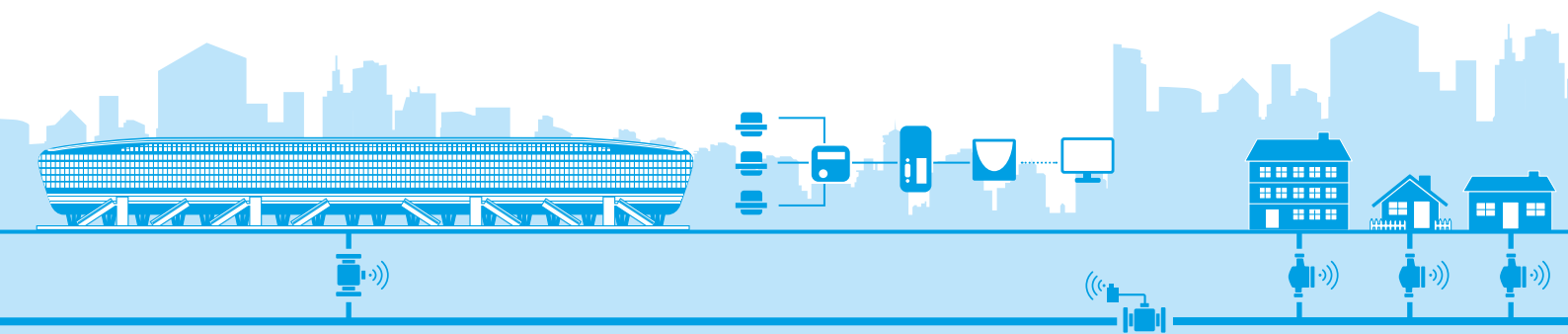
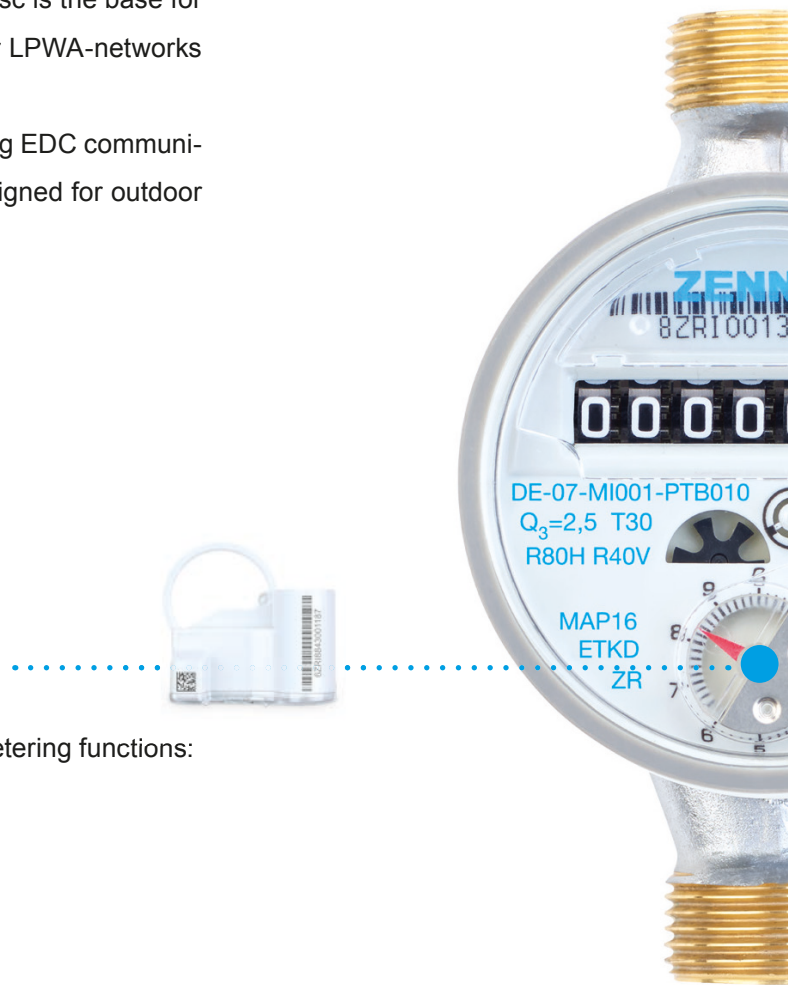



### Electronic Pulsar and M-Bus



- Integration into M-Bus systems
- Connection to a GSM data logger
  - Leak detection
  - Remote readout via GSM
  - Pipe burst
- Errors

Learn more about M-Bus: [www.zenner.com/bus-systems.html](http://www.zenner.com/bus-systems.html)

Learn more about GSM: [www.zenner.com/gsm.html](http://www.zenner.com/gsm.html)

### Walk-by / drive-by radio system OPERA



- Wireless M-Bus radio technology according to OMS
- Unidirectional radio technology according to EN 13757-4 and OMS-specification
- Compatible to various mobile readout-systems
- Frequency: 868MHz
- Transmitting power: 25mW
- Battery lifetime: up to 15 years

Learn more about wireless M-Bus: [www.zenner.com/opera.html](http://www.zenner.com/opera.html)

### Stationary Radio System (Internet of Things)



- Bidirectional LPWAN radio technology (Low Power Wide Area Network)
- Integration of meters into the Internet of Things (IoT)
- Using the international communication standard LoRaWAN™
- Using the international communication standard SIGFOX

Learn more about the Internet of Things: [www.zenner.com/iot.html](http://www.zenner.com/iot.html)



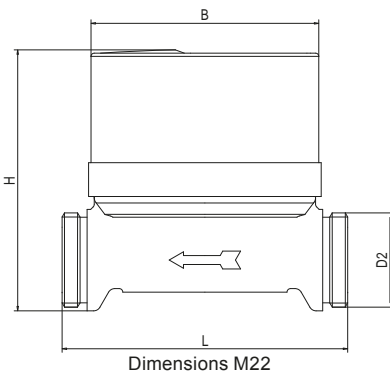
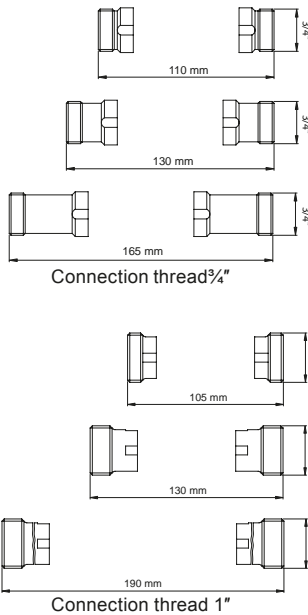

Dimensions M22

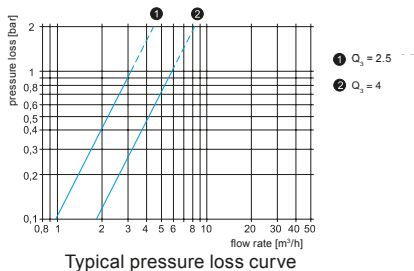

Typical pressure loss curve

# Universal meter M22

## Surface-mounted meter suitable for all installation situations

The universal meter M22 is suitable for a variety of application situations due to its range of adapter pieces. Its advantages are shown in the meter exchange. With the different adapter pieces you can select the right configuration for the respective installation situation on the location.

The adapter fittings with integrated o-ring seals allow an individual installation length adjustment from 110 to 165 mm at 3/4"-threads and 105 to 190 mm at 1"-threads. The meter can be retrofitted with pulse module (1 l/pulse).

### Performance characteristics in overview

- Single-jet dry dial meter with magnetic coupling
- For variable installation with length adjustment pieces
- For horizontal and vertical installation
- Approved in accordance with MID

### Applications

- For the consumption measuring of cold potable water up to 30 °C or hot water up to 90 °C

Technical data M22							
Permanent flow	Q <sub>3</sub>	m <sup>3</sup> /h	2.5	2.5	4	4	
Comparable to nominal flow (EWG)	Q <sub>n</sub>	m <sup>3</sup> /h	1.5	1.5	2.5	2.5	
Standard measuring range	Q <sub>3</sub> /Q <sub>1</sub>	R	40H/40V	40H/40V	40H/40V	40H/40V	
Comparable to metrological Class (EWG)	class		A-H/A-V	A-H/A-V	A-H/A-V	A-H/A-V	
Overload Flowrate	Q <sub>4</sub>	m <sup>3</sup> /h	3.125	3.125	5	5	
Minimum flow	Q <sub>1</sub>	l/h	62.5	62.5	100	100	
<b>Weight and dimensions:</b>							
Overall length	L	mm	80	80	80	80	
Installation length		mm	110/130/165	105/130/190	110/130/165	105/130/190	
Thread meter	D2		M22	M22	M22	M22	
Connection thread	GxB	inch	3/4	1	3/4	1	
Width	B	mm	65	65	65	65	
Height	H	mm	71	71	71	71	
Weight		kg	0.42	0.42	0.42	0.42	

# Measuring capsule replacement program

## Flush-mounted water meter for the individual utility bill

As part of the regular exchange, installers are frequently confronted with the task of switching water meters from different manufacturers ZENNER's comprehensive replacement program offers customized solutions for nearly all measuring capsules and adapter fittings on the market.

According to DIN EN ISO 4064, newly approved measuring capsules counters and their associated connection interfaces are provided with a corresponding type identification. This is alphanumeric and three-digit:

- A34: Type Allmess
- IST: Type Ista
- M7L: Type Minol micro
- MB2: Type Minol MB2
- MB3: Type Minol MB3
- MET: Type Metrona
- MOC / MOE: Type Elster / ABB
- MUK: Type Sensus
- TE1: Type Techem
- WE1: Type Wehrle

It is necessary to verify the conformity of these labels before installation. If capsule meters need to be replaced in an existing building and the connection point does not have a DIN-conforming label, ZENNER product support will help you select the right measuring capsule.



Article	compatible to	Size	Thread	Temperature
Minolist	Ista (Koax)	Q <sub>3</sub> = 2.5	G2B	30 °C/ 90 °C
Minolas	Allmess, Kalorimeta	Q <sub>3</sub> = 2.5	M77x1.5	30 °C/ 90 °C
Minotec	Techem-Vario	Q <sub>3</sub> = 2.5	M62x2	30 °C/ 90 °C
Minomoc	Elster, Kundo, ABB, Andrae	Q <sub>3</sub> = 2.5	M65x2	30 °C/ 90 °C
Minomet	Metrona 307/A	Q <sub>3</sub> = 2.5	M64x2	30 °C/ 90 °C
Minomess BR	Metrona HT2 307/1	Q <sub>3</sub> = 2.5	M66x1	30 °C/ 90 °C
Minomuk	Pollumuk	Q <sub>3</sub> = 2.5	G 2 ¼"	30 °C/ 90 °C
Minomess WE	SPX, Rosswein, ZR-Neptun	Q <sub>3</sub> = 2.5	M78x1.5	30 °C/ 90 °C
micro		Q <sub>3</sub> = 2.5	M58x1.5	30 °C/ 90 °C
MB3		Q <sub>3</sub> = 2.5	M76x1,5	30 °C/ 90 °C
MB2		Q <sub>3</sub> = 2.5	M80x1.5	30 °C/ 90 °C
Minomess DM	Deltamess TK	Q <sub>3</sub> = 2.5	M60x2	30 °C/ 90 °C
Minomess WG	Wasser Geräte up to 83/84	Q <sub>3</sub> = 2.5	M66x1.25	30 °C/ 90 °C



## Measuring capsule Minolist

### Measuring capsule for apartments and flats

Minolist is a coaxial measuring capsule water meter with 2" connection thread according to the multiple jet principle with modular counter for connection points according to DIN EN ISO 4064 (Type ISTA).

This counter also has a module design with 7-digit register and can be equipped with optional modules. The current connection dimension allows for use in both flush-mounted connection interfaces as well as in surface-mounted fittings.

### Performance characteristics in overview

- Coaxial-Capsule meter
- Easy installation and quick exchange
- Can be installed in the narrowest of spaces
- Compatibility with existing systems
- High level of measurement stability due to high-quality sapphire bearing for the impeller
- Thanks to the rotary counter can be read in any position
- The ER2 measuring capsule must be used for vertical installation in the ZENNER Block 2" mounting block
- Approved in accordance with MID

### Applications

- For the consumption measuring of cold potable water up to 30 °C or hot water up to 90 °C

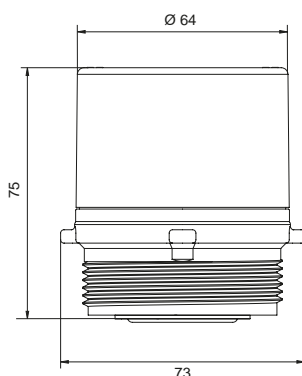

Dimensions Minolist

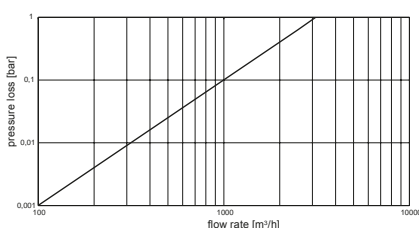

Typical pressure loss curve

### Technical data Minolist

Permanent flow	$Q_3$	m <sup>3</sup> /h	2.5
Comparable to nominal flow (EWG)	$Q_n$	m <sup>3</sup> /h	1.5
Standard measuring range	$Q_3/Q_1$	R	40V
Comparable to metrological Class (EWG)	class		A-V
Overload flowrate	$Q_4$	m <sup>3</sup> /h	3.125
Minimum flow	$Q_1$	l/h	62.5

### Weight and dimensions:

Thread meter	D2	inch	2
Width cover of the register		mm	64
Total width		mm	73
Height	H	mm	75
Weight		kg	0.44



## ZENNER Flush mounting block 2"

### Mounting block for measuring capsule Minolist

Two one-piece manifold bodies with integrated sliding pistons are embedded in the heat and sound-insulating casing. Meter and valves can be assembled simply in a single process without prior alignment. The mounting block is available in all standard connection variations and dimensions and is thus suitable for assembly in masonry, rear walls and sides as well as for wall-mounted installation. The ZENNER Block 2" is especially suited to confined installation situations.

A one-piece rosette encloses both water meters and the water shut-off valves. The mounting block can be quickly separated from a duo-block to a mono-block by means of a saw groove.

### Performance characteristics in overview

- Water meter block for flush-mounted installation
- Smallest installation dimensions
- One-piece brass flush-mounting units with integrated sliding pistons
- Material of the connection interface available in brass or gunmetal
- No sealing point within the block
- Installation in vertical pipes
- For the inclusion of Minolist flush mount meter
- In accordance with the application standard
- One-piece rosette to cover the ZENNER-Block 2" (one-piece rosette for covering both counters and piston slides)
- Optional: Red Bronze against dezincification

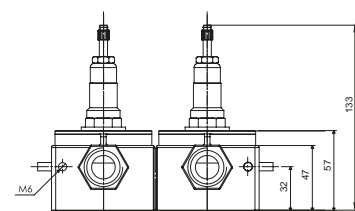
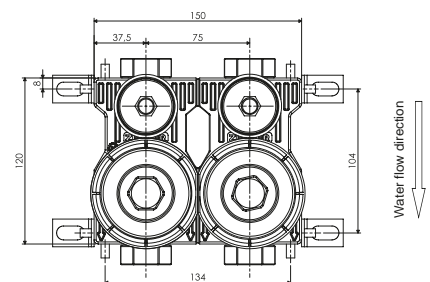
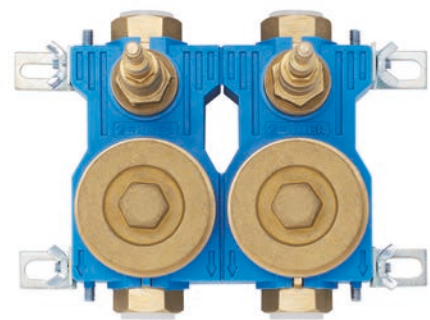

Technical data		
Dimensions	Width	150 mm
	Height	120 mm
	Depth	47 mm
Connection thread	Rp	3/4"
Installation	in vertical pipes	

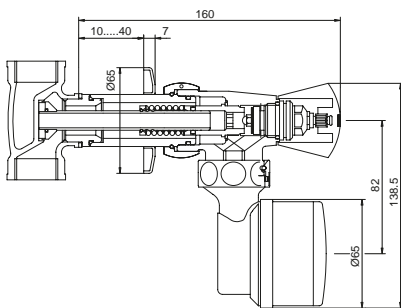

## Valve meter type MC

### Retrofittable meter for valve connection (cold and hot water)

The MC valve meter is ideally suitable for installation into existing flush-mounted  $\frac{1}{2}$  inch,  $\frac{3}{4}$  inch, 1 inch and 1  $\frac{1}{4}$  inch cut-off valves. Hence, it is guaranteed that only the water usage of each user can be allocated to him.

#### Technical data valve meter type MC

Permanent Flowrate	$Q_3$	m <sup>3</sup> /h	2.5
Comparable to nominal flow (EWG)	$Q_n$	m <sup>3</sup> /h	1.5
Standard measuring range	$Q_3/Q_1$	R	40H/40V
Comparable to metrological Class (EWG)	class		A-H/A-V
Overload Flowrate	$Q_4$	m <sup>3</sup> /h	3.125
Minimum flow	$Q_1$	l/h	62.5

#### Weight and dimensions:

Rosette diameter	mm	65
Valve dimension	inch	$\frac{1}{2}$ ; $\frac{3}{4}$ ; 1; 1 $\frac{1}{4}$
Weight	kg	0.44

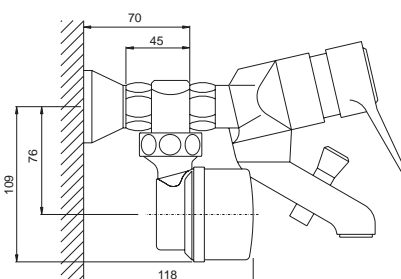

## Bathtub meter type MC

### Retrofittable meter for bathtub connections (cold and hot water)

The MC bathtub water meter with modular counter can be easily installed between the S-connector on the bathtub and the mixer tap.

#### Technical data bathtub meter type MC

Permanent Flowrate	$Q_3$	m <sup>3</sup> /h	2.5
Comparable to nominal flow (EWG)	$Q_n$	m <sup>3</sup> /h	1.5
Standard measuring range	$Q_3/Q_1$	R	40H/40V
Comparable to metrological Class (EWG)	class		A-H/A-V
Overload Flowrate	$Q_4$	m <sup>3</sup> /h	3.125
Minimum flow	$Q_1$	l/h	62.5

#### Weight and dimensions:

Connection thread	GxB	inch	$\frac{3}{4}$
Weight		kg	0.44

## Washbasin meter

### Retrofittable meter for washbasin connections (cold and hot water)

The ZENNER washbasin meter is a retrofittable meter for the installation on the existing angle valve under the washbasin.

Technical data washbasin meter			
Permanent Flowrate	$Q_3$	$m^3/h$	2.5
Comparable to nominal flow (EWG)	$Q_n$	$m^3/h$	1.5
Standard measuring range	$Q_3/Q_1$	R	80H/40V
Comparable to metrological Class (EWG)	class		B-H/A-V
Overload Flowrate	$Q_4$	$m^3/h$	3.125
Minimum flow	$Q_1$	l/h	31H/62.5V
<b>Weight and dimensions:</b>			
Overall length meter		mm	80
Installation length		mm	125
Connection thread	GxB	inch	$\frac{3}{4}$
Height meter approx.		mm	77
Weight ca.		kg	0.42

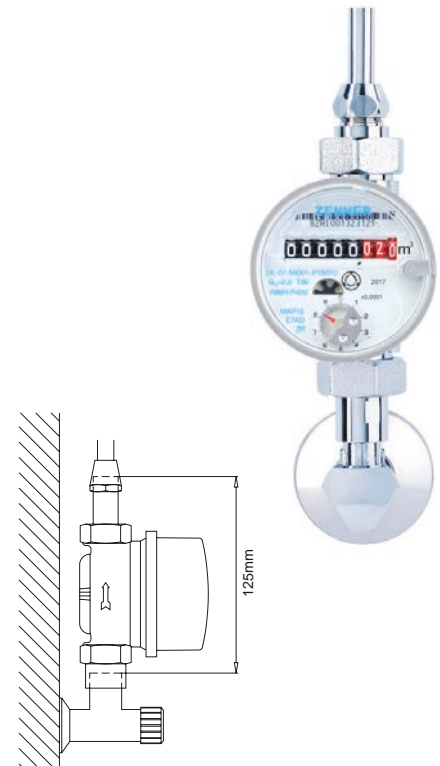

## Tap meter

### Retrofittable meter for tap connections (cold and hot water)

The ZENNER tap meter, with its special connection, can be installed on all common taps. With its seal, the water meter connector protects the unit from tampering.

Technical data tap meter			
Permanent Flowrate	$Q_3$	$m^3/h$	2.5
Comparable to nominal flow (EWG)	$Q_n$	$m^3/h$	1.5
Standard measuring range	$Q_3/Q_1$	R	80H/40V
Comparable to metrological Class (EWG)	class		B-H/A-V
Overload Flowrate	$Q_4$	$m^3/h$	3.125
Minimum flow	$Q_1$	l/h	31H/62.5V
<b>Weight and dimensions:</b>			
Overall length meter		mm	80/110
Connection thread	GxB	inch	$\frac{3}{4}$
Height meter approx.		mm	77
Weight ca.		kg	0.42/0.44

